



June 15, 2023

Lori Brocker
Secretary of the Senate

James Goulding
Publications Coordinator

Subject: Vote Explanation HB 2005

Dear Secretary Brocker and Publications Coordinator Goulding-

Please accept this vote explanation for HB 2005 to become a permanent entry in the journal:

Attached memo, one page, from the Department of Justice dated June 15, 2023, stating in part: "This letter is provided as clarification as to the intent of HB 2005. We want to avoid any confusion when it comes to AR platforms and the upper receiver in those models."

Attached an eight page "Definitional intent HB 2005".

Thank you.

Respectfully submitted,

Senator Tim Knopp
Senate 27

ELLEN F. ROSENBLUM
Attorney General



LISA UDLAND
Deputy Attorney General

DEPARTMENT OF JUSTICE
OFFICE OF THE ATTORNEY GENERAL

DATE: June 15, 2023

FROM: Kimberly McCullough, Legislative Director
Oregon Department of Justice

SUBJECT: HB 2005 – Ghost Guns – Clarification for the Record

This letter is provided as clarification as to the intent of HB 2005.

We want to avoid any confusion when it comes to AR platforms and AR-15 style rifles. HB 2005 is only intended to regulate the lower receiver and not the upper receiver in those models.

Contact:

Kate Denison, Deputy Legislative Director, 971-599-9851, kate.e.denison@doj.state.or.us

Kimberly McCullough, Legislative Director, 503-931-0418, kimberly.mccullough@doj.state.or.us



Displaying title 27, up to date as of 6/09/2023. Title 27 was last amended 3/24/2023.

Title 27 –Alcohol, Tobacco Products and Firearms
Chapter II –Bureau of Alcohol, Tobacco, Firearms, and Explosives, Department of Justice
Subchapter B –Firearms and Ammunition
Part 478 – Commerce in Firearms and Ammunition
Subpart B –Definitions

EDITORIAL NOTE ON PART 478

Editorial Note: Nomenclature changes to part 478 appear by T.D. ATF-411, 64 FR 17291, Apr. 9, 1999, T.D. ATF-487, 68 FR 3750, Jan. 24, 2003, and ATF-11F, 73 FR 57240, Oct. 2, 2008.

§ 478.12 Definition of Frame or Receiver.

- (a) Except as otherwise provided in this section, the term “frame or receiver” means the following—
- (1) The term “frame” means the part of a handgun, or variants thereof, that provides housing or a structure for the component (*i.e.*, sear or equivalent) designed to hold back the hammer, striker, bolt, or similar primary energized component prior to initiation of the firing sequence, even if pins or other attachments are required to connect such component (*i.e.*, sear or equivalent) to the housing or structure.
 - (2) The term “receiver” means the part of a rifle, shotgun, or projectile weapon other than a handgun, or variants thereof, that provides housing or a structure for the primary component designed to block or seal the breech prior to initiation of the firing sequence (*i.e.*, bolt, breechblock, or equivalent), even if pins or other attachments are required to connect such component to the housing or structure.
 - (3) The terms “variant” and “variants thereof” mean a weapon utilizing a similar frame or receiver design irrespective of new or different model designations or configurations, characteristics, features, components, accessories, or attachments. For example, an AK-type firearm with a short stock (*i.e.*, pistol grip) is a pistol variant of an AK-type rifle, an AR-type firearm with a short stock (*i.e.*, pistol grip) is a pistol variant of an AR-type rifle, and a revolving cylinder shotgun is a shotgun variant of a revolver.
 - (4) The following are nonexclusive examples that illustrate the above definitions:
 - (i) **Hinged or single framed revolvers:** The frame is the part of the revolver that provides a structure designed to hold the sear.

Figure 1 to paragraph (a)(4)(i)

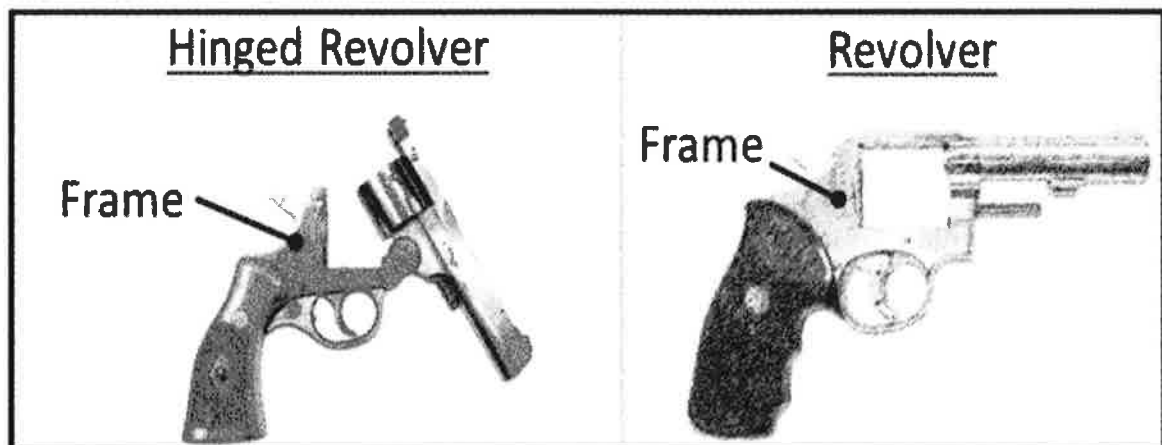

- (ii) *Colt 1911, Beretta/Browning/FN Herstal/Heckler & Koch/Ruger/Sig Sauer/Smith & Wesson/Taurus hammer-fired semiautomatic pistols*: The frame is the lower portion of the pistol, or grip, that provides housing for the sear.

Figure 2 to paragraph (a)(4)(ii)

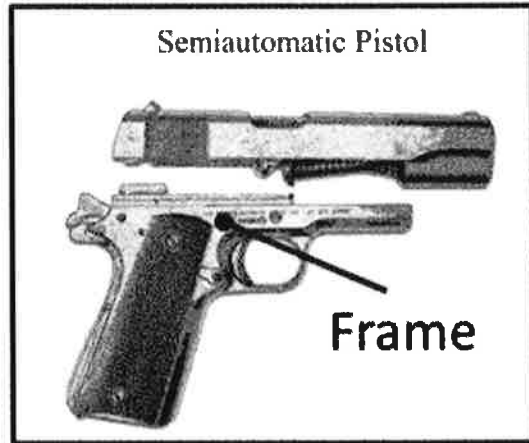

- (iii) *Glock variant striker-fired semiautomatic pistols*: The frame is the lower portion of the pistol, or grip, that provides housing for the sear.

Figure 3 to paragraph (a)(4)(iii)

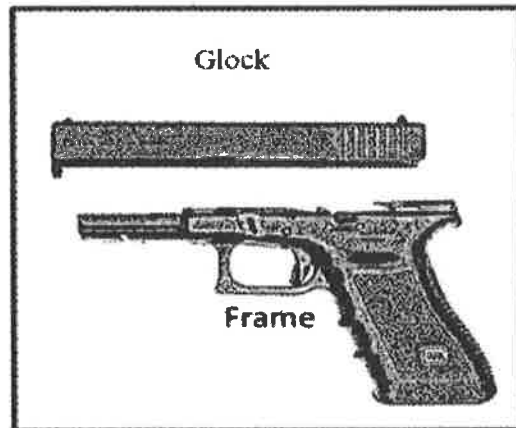

- (iv) *Sig Sauer P250/P320 variant semiautomatic pistols*: The frame is the internal removable chassis of the pistol that provides housing for the sear or equivalent component.

Figure 4 to paragraph (a)(4)(iv)



(v) **Bolt action rifles:** The receiver is the part of the rifle that provides a structure for the bolt.

Figure 5 to paragraph (a)(4)(v)

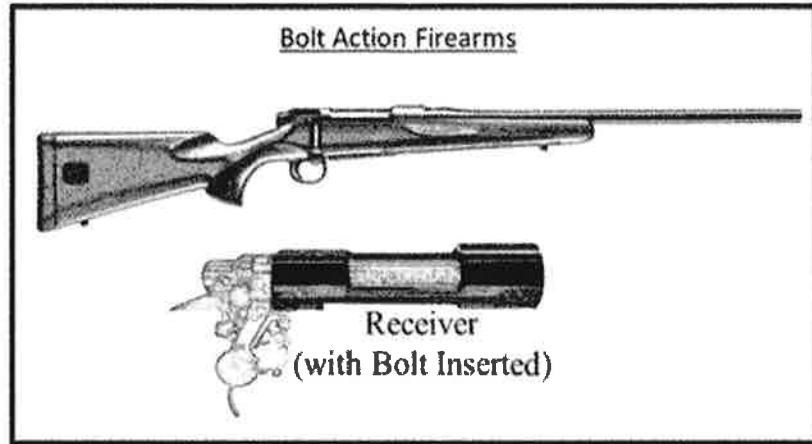

(vi) **Break action, lever action, or pump action rifles and shotguns:** The receiver is the part of the rifle or shotgun that provides housing for the bolt, breechblock, or equivalent.

Figure 6 to paragraph (a)(4)(vi)

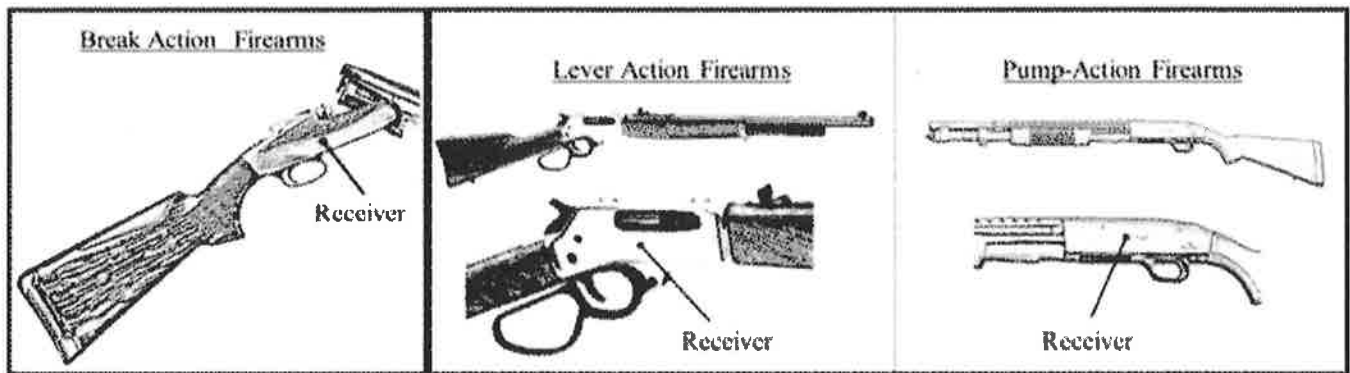

(vii) **AK variant firearms:** The receiver is the part of the weapon that provides housing for the bolt.

Figure 7 to paragraph (a)(4)(vii)

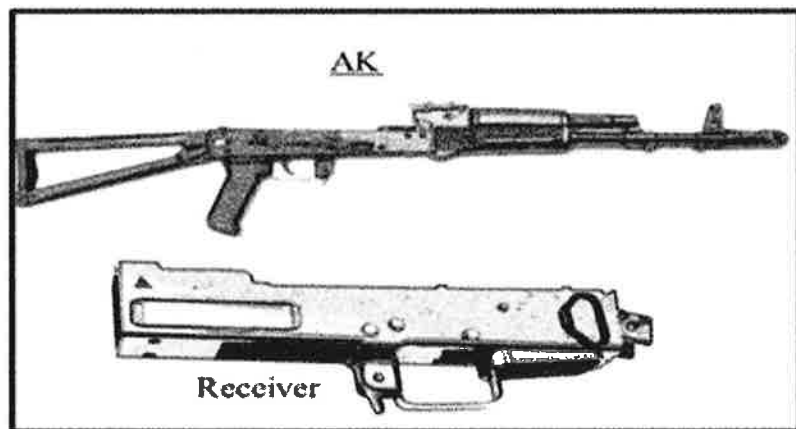

(viii) **Steyr AUG variant firearms:** The receiver is the central part of the weapon that provides housing for the bolt.

Figure 8 to paragraph (a)(4)(viii)

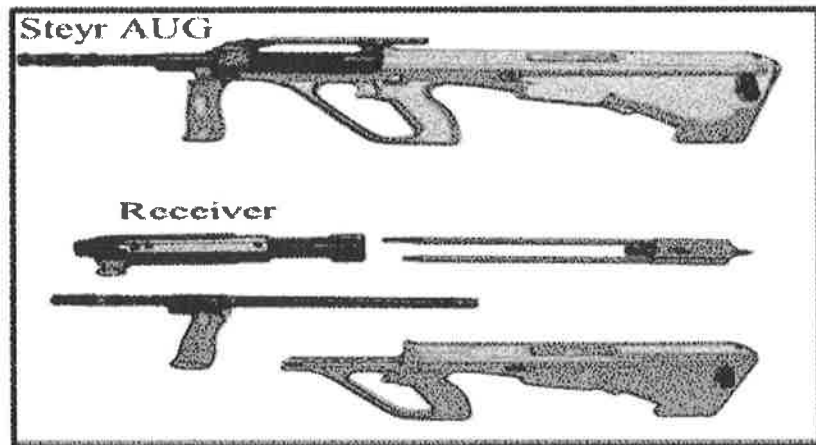

- (ix) *Thompson machineguns and semiautomatic variants, and L1A1, FN FAL, FN FNC, MP38, MP40, and SIG 550 firearms, and HK machineguns and semiautomatic variants:* The receiver is the upper part of the weapon that provides housing for the bolt.

Figure 9 to paragraph (a)(4)(ix)

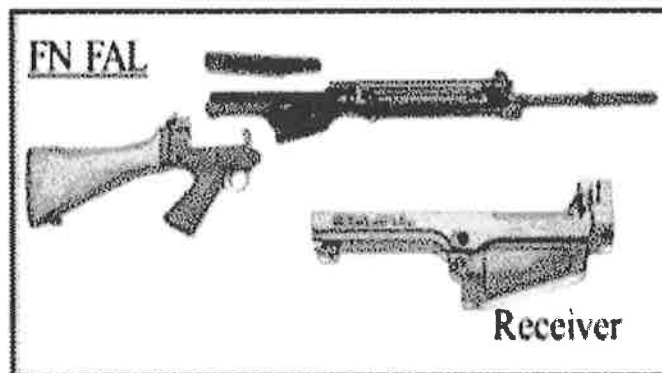
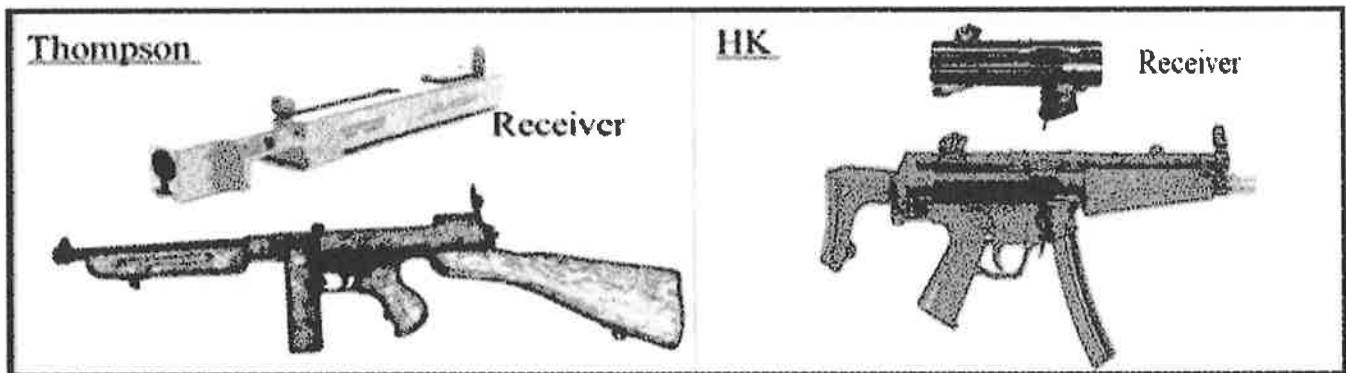

- (x) *Sten, Sterling, and Kel-Tec SUB-2000 firearms:* The receiver is the central part of the weapon, or tube, that provides housing for the bolt.

Figure 10 to paragraph (a)(4)(x)

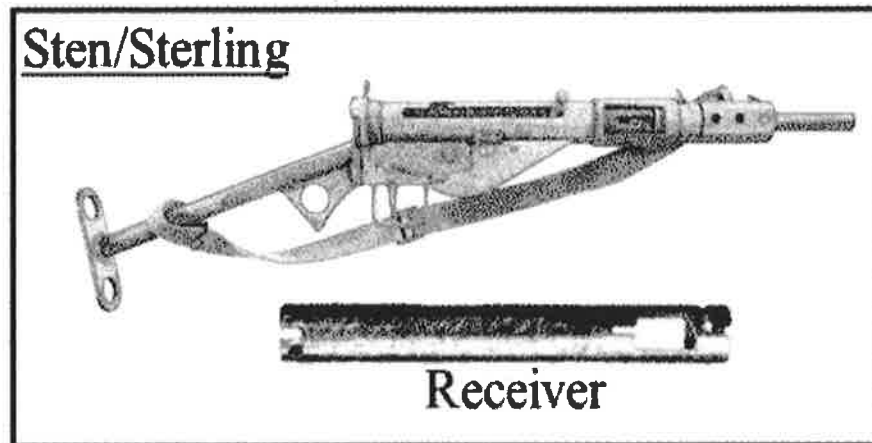

- (b) **Firearm muffler or silencer frame or receiver.** The terms “frame” and “receiver” shall mean, in the case of a firearm muffler or firearm silencer, the part of the firearm, such as an outer tube or modular piece, that provides housing or a structure for the primary internal component designed to reduce the sound of a projectile (i.e., baffles, baffling material, expansion chamber, or equivalent). In the case of a modular firearm muffler or firearm silencer device with more than one such part, the terms shall mean the principal housing attached to the weapon that expels a projectile, even if an adapter or other attachments are required to connect the part to the weapon. The terms shall not include a removable end cap of an outer tube or modular piece.
- (c) **Partially complete, disassembled, or nonfunctional frame or receiver.** The terms “frame” and “receiver” shall include a partially complete, disassembled, or nonfunctional frame or receiver, including a frame or receiver parts kit, that is designed to or may readily be completed, assembled, restored, or otherwise converted to function as a frame or receiver, i.e., to house or provide a structure for the primary energized component of a handgun, breech blocking or sealing component of a projectile weapon other than a handgun, or internal sound reduction component of a firearm muffler or firearm silencer, as the case may be. The terms shall not include a forging, casting, printing, extrusion, unmachined body, or similar article that has not yet reached a stage of manufacture where it is clearly identifiable as an unfinished component part of a weapon (e.g., unformed block of metal, liquid polymer, or other raw material). When issuing a classification, the Director may consider any associated templates, jigs, molds, equipment, tools, instructions, guides, or marketing materials that are sold, distributed, or possessed with the item or kit, or otherwise made available by the seller or distributor of the item or kit to the purchaser or recipient of the item or kit. The following are nonexclusive examples that illustrate the definitions:

Example 1 to paragraph (c)—Frame or receiver: A frame or receiver parts kit containing a partially complete or disassembled billet or blank of a frame or receiver that is sold, distributed, or possessed with a compatible jig or template is a frame or receiver, as a person with online instructions and common hand tools may readily complete or assemble the frame or receiver parts to function as a frame or receiver.

Example 2 to paragraph (c)—Frame or receiver: A partially complete billet or blank of a frame or receiver with one or more template holes drilled or indexed in the correct location is a frame or receiver, as a person with common hand tools may readily complete the billet or blank to function as a frame or receiver.

Example 3 to paragraph (c)—Frame or receiver: A complete frame or receiver of a weapon that has been disassembled, damaged, split, or cut into pieces, but not destroyed in accordance with paragraph (e), is a frame or receiver.

Example 4 to paragraph (c)—Not a receiver: A billet or blank of an AR-15 variant receiver without critical interior areas having been indexed, machined, or formed that is not sold, distributed, or possessed with instructions, jigs, templates, equipment, or tools such that it may readily be completed is not a receiver.

Example 5 to paragraph (c)—Not a receiver: A flat blank of an AK variant receiver without laser cuts or indexing that is not sold, distributed, or possessed with instructions, jigs, templates, equipment, or tools is not

a receiver, as a person cannot readily fold the flat to provide housing or a structure for the primary component designed to block or seal the breech prior to initiation of the firing sequence.

- (d) **Multi-piece frame or receiver.** The term "multi-piece frame or receiver" shall mean a frame or receiver that may be disassembled into multiple modular subparts, *i.e.*, standardized units that may be replaced or exchanged. The term shall not include the internal frame of a pistol that is a complete removable chassis that provides housing for the sear or equivalent component, unless the chassis itself may be disassembled. The modular subpart(s) identified in accordance with § 478.92 with an importer's or manufacturer's serial number shall be presumed, absent an official determination by the Director or other reliable evidence to the contrary, to be part of the frame or receiver of a weapon or device.
- (e) **Destroyed frame or receiver.** The terms "frame" and "receiver" shall not include a frame or receiver that is destroyed. For purposes of these definitions, the term "destroyed" means that the frame or receiver has been permanently altered such that it may not readily be completed, assembled, restored, or otherwise converted to function as a frame or receiver. Acceptable methods of destruction include completely melting, crushing, or shredding the frame or receiver, or other method approved by the Director.
- (f)
- (1) **Frame or receiver classifications based on which part of the weapon was classified as such before April 26, 2022.** Except as provided in paragraph (f)(2) of this section, the terms "frame" and "receiver" shall include the specific part of a complete weapon, including variants thereof, determined (classified) by the Director to be defined as a firearm frame or receiver prior to April 26, 2022. Any such part that is identified with an importer's or manufacturer's serial number shall be presumed, absent an official determination by the Director or other reliable evidence to the contrary, to be the frame or receiver of the weapon. The following is a nonexclusive list of such weapons and the specific part determined by the Director to be the firearm frame or receiver as they existed on that date:
- (i) **AR-15/M-16 variant firearms:** The receiver is the lower part of the weapon that provides housing for the trigger mechanism and hammer (*i.e.*, lower receiver).

Figure 11 to paragraph (f)(1)(i)

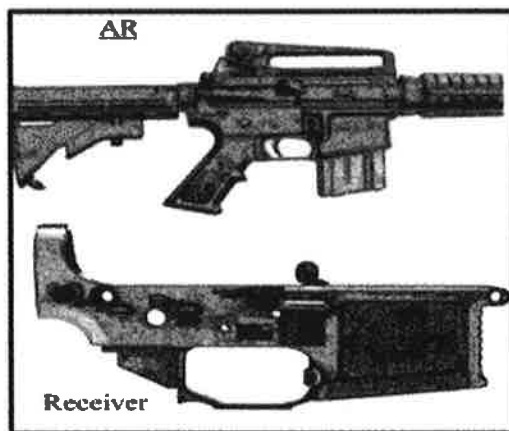

- (ii) **Ruger Mark IV pistol:** The frame is the upper part of the weapon that provides housing for the bolt or breechblock.

Figure 12 to paragraph (f)(1)(ii)

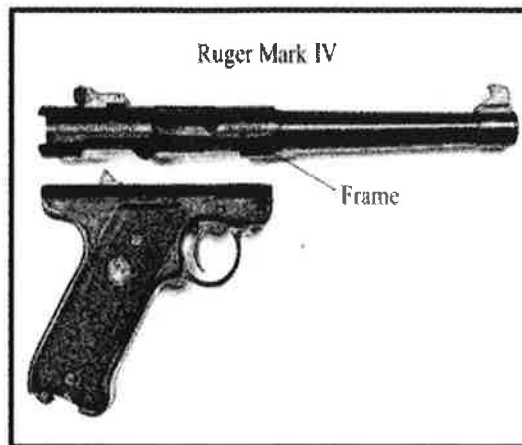

- (iii) **Benelli 121 M1 Shotgun:** The receiver is the lower part of the weapon that provides housing for the trigger mechanism.

Figure 13 to paragraph (f)(1)(iii)

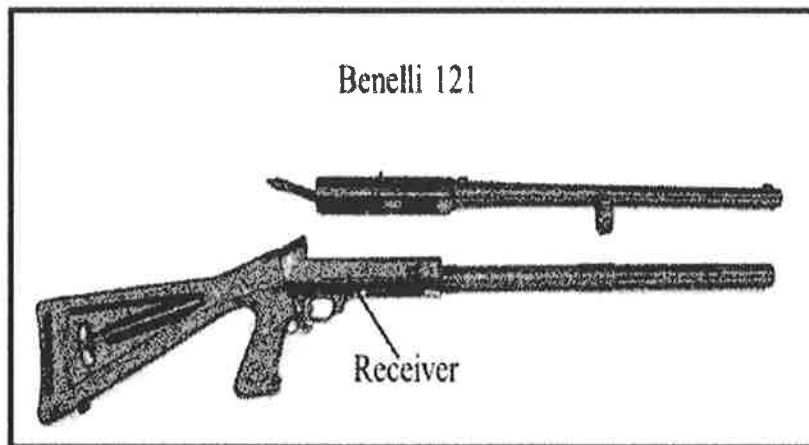

- (iv) **Vickers/Maxim, Browning 1919, M2, and box-type machineguns and semiautomatic variants:** The receiver is the side plate of the weapon that is designed to hold the charging handle.

Figure 14 to paragraph (f)(1)(iv)

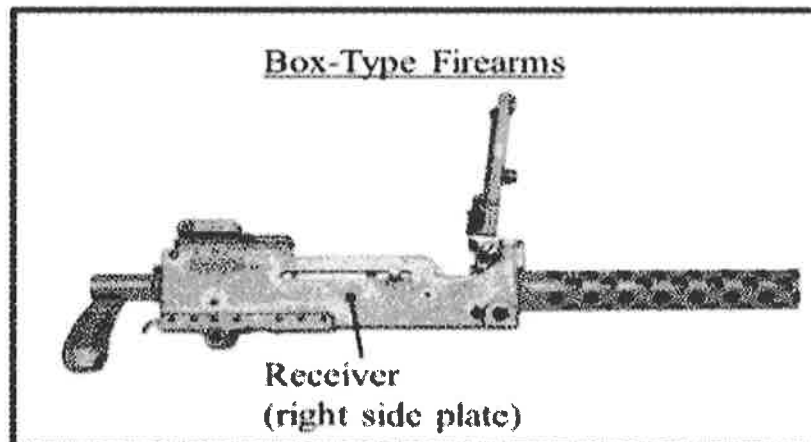

- (2) **Frame or receiver classifications of partially complete, disassembled, or nonfunctional frames or receivers before April 26, 2022.** Prior determinations by the Director that a partially complete, disassembled, or nonfunctional frame or receiver, including a parts kit, was not, or did not include, a "firearm frame or receiver" under § 478.11, or "frame or receiver" under § 479.11 of this subchapter, as those terms were defined prior to

April 26, 2022, shall not continue to be valid or authoritative after that date. Such determinations shall include those in which the Director determined that the item or parts kit had not yet reached a stage of manufacture to be, or include, a "firearm frame or receiver" under § 478.11, or "frame or receiver" under § 479.11 of this subchapter, as those terms were defined prior to April 26, 2022.

[ATF-2021R-05F, 87 FR 24735, Apr. 26, 2022; 87 FR 51249, 51250, Aug. 22, 2022]